

LED FLOODLIGHT RX-FL-F 150

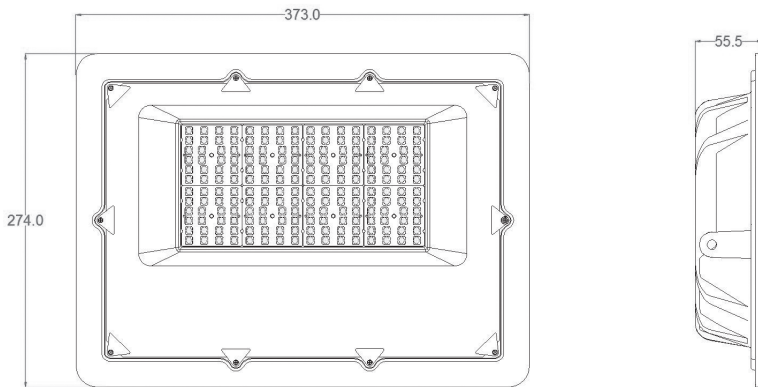

Rated power: **150W**
Input voltage: **AC100-277V 50/60Hz**
Power factor: **>0,95**
Electrical class: **CL I**
Surge protection: **Built-in 6KV**

Color temperature: **4000K**
Color rendering: **Ra>75**
Efficiency: **120Lm/W**
Beam angle: **150°x70° asymmetric**
LED brand: **Philips 3030**
LED numbers: **192**



- Aluminium alloy housing with high transparent tempered glass
- Anti-condensate valve at the bottom of the housing
- Mounting with adjustable bracket.
- Replacement for luminaires with mercury vapor or metal halide lamps
- High luminous efficiency
- Long lifetime >50.000h
- Black color



RELAXO[®]

www.relaxo.lighting